

## 820.045.075 BÖJ 45°

-Diameter: Ø75 mm  
-Rostfritt stål: AISI304/EN1.4301

### Produktkoder

EAN: 5705499401325  
LVI-nummer: 0240683  
NRF-nummer: 2170055  
RSK-nummer: 1550090  
VVS-nummer: 160205075

### Specifikation

Material: AISI 304  
Material (EN): EN 1.4301  
Utloppsdiаметer (mm): 75  
Vikt (kg): 0,30



### Godkännanden

-  AUS - WMKT00204 - 24
-  BLÜCHER® EuroPipe EPD
-  DE - TÜV Rheinland R 60178453 0001
-  DK - VA 2.12/19349 EuroPipe DS432
-  HACCP Food Safety Programme - Australasia
-  HACCP Food Safety Programme - Europe
-  NO - 0692-22 EuroPipe
-  TÜRK LOYDU - 25041616077231247
-  US - IAPMO File No.3247-EuroPipe

ABS - 23-2329630-PDA  
Achilles Certificate - 46702  
Bureau Veritas, 02375-I0 Pipes & Fittings  
DNV - TAP0000023-rev5, Sanitary discharge pipes  
KR - Type Approval CPH42135-PE001  
Lloyds Register LR22419510TA\_02  
MARINE - R4547 NATO CODIFICATION SYSTEM  
PL - Hygienic Certificate - All Products

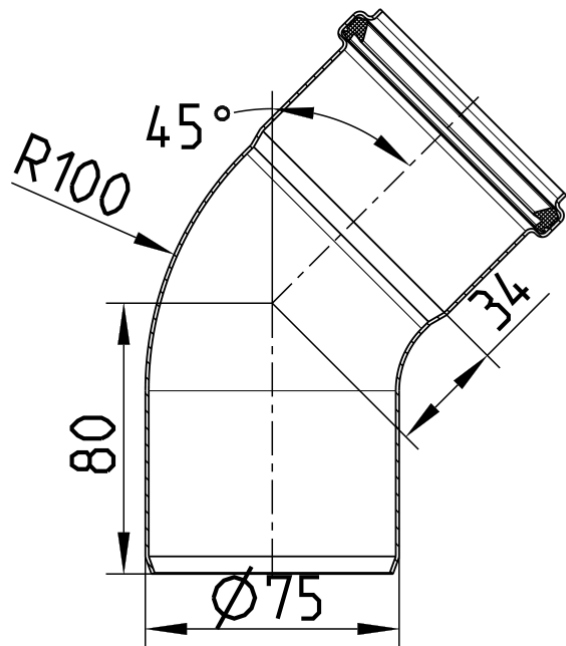

# BLÜCHER®

## Godkännanden

RINA -MAC320524XG EuroPipe

UR - 1055745 Product approval, EuroPipe and Drains

